

ZIGEN LED DATASHEET

Series Part Number

ZG1BxCxxF00

Contents	Page
1 Product Description & Features	2
2 External Dimension & Circuit diagrams	3
3 Ratings and Characteristics	4-9
1) Absolute Maximum Ratings	
2) Electro-Optical Characteristics	
3) Chromaticity Characteristics	
4) Derating Curve	
5) Characteristics Diagram (TYP.)	
6) Spectrum and Color (Reference)	
4 Reliability	10
5 Packing and Labels	11
6 Precautions	12~13

1. Product Description

ZIGEN is targeting to professional lighting market from innovative concepts and quality driven development.

ZG1BxCxxKH0 is under ZIGEN I series (ZG1) with features below

- Mechanical Dimensions : 12.0 x 15.0 x 1.4 (mm)
- Substrate : Alumina Ceramic

ZG1 B x C xx F 0 0
 [1] [2] [3] [4] [5] [6] [7] [8]

[1]	Series code	ZG1
[2]	Substrate size	B (15x12mm)
[3]	CRI	M (>80) G (>90)
[4]	Chip Layout	C (3s4p)
[5]	Color code	27 (2700K) 30 (3000K) 35 (3500K) 40 (4000K) 50 (5000K)
[6]	LES	F (7mm)
[7]	-	0
[8]	Custom code	0 (standard)

2. External Dimension & Circuit Diagram

- External Dimension

Unit : mm

Tolerances unless specified : +/-0.1

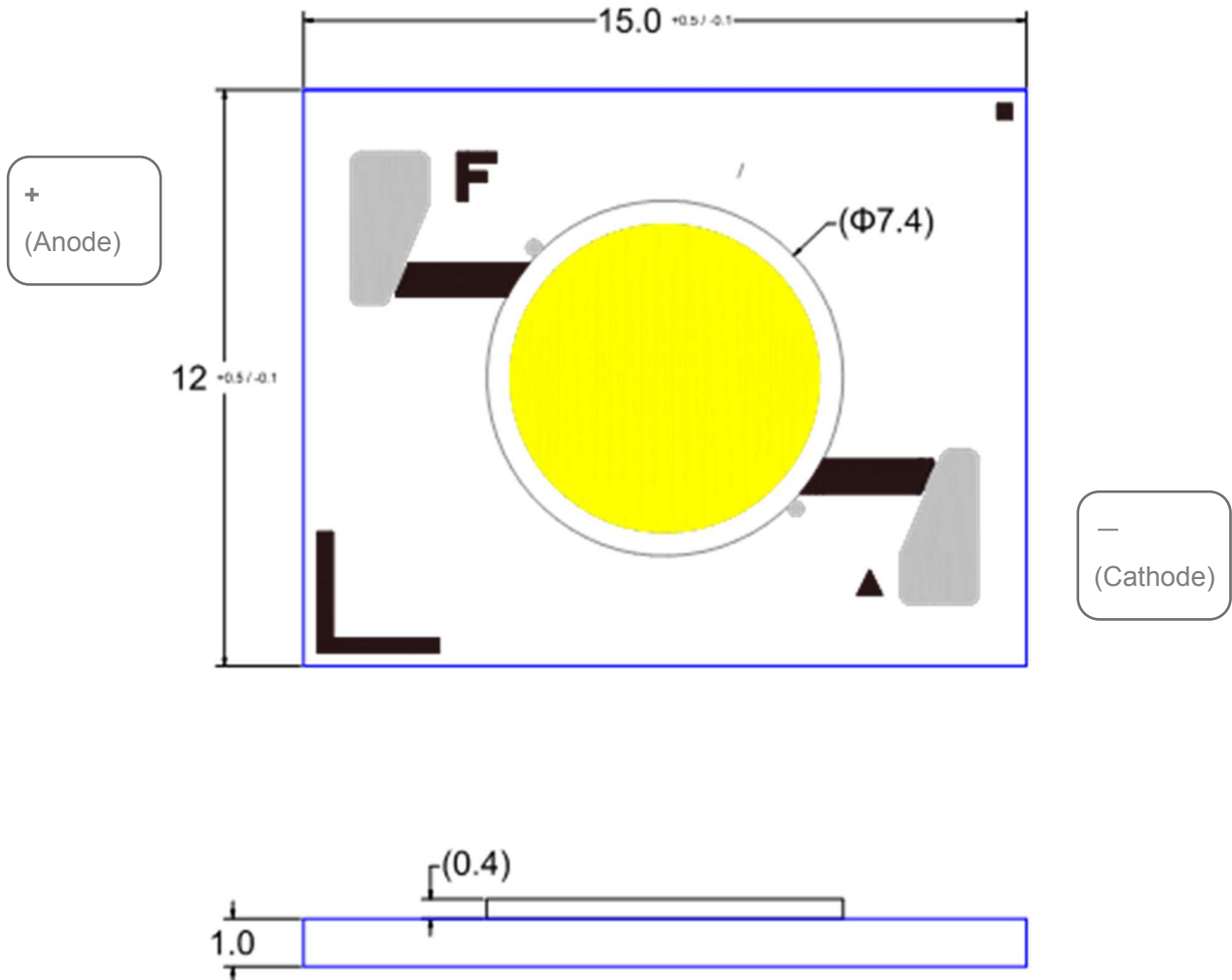

- Notes:
- Values inside parentheses are reference values.
 - External sizes of are determined by maximum dimensions, that include salient areas on the edges of respective sides.
 - Distance from bottom of substrate to electrode is typical 2.0mm (reference)
 - Inner edge of green line has 1.2mm from bottom of substrate.

- Internal circuit

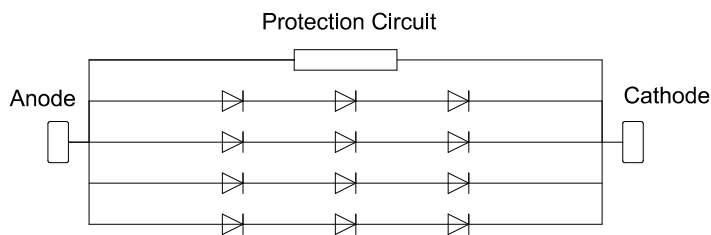

(Note) Protection circuit has resistor typical 20MΩ

3. Ratings and Characteristics

3-1) Absolute maximum ratings

Parameter	Symbol	Ratings	Unit
Max. DC Forward Current (mA) ※1,4	I _F	700	mA
Power Dissipation ※1,4	P _d	7.0	W
Reverse Voltage ※2,4	V _R	-15	V
Max. Junction Temperature	T _j	145	°C
Operating Temperature ※3	T _{Opr}	-30 ~ +100	°C
Storage Temperature	T _{Stg}	-40 ~ +100	°C

Notes:

- ※ 1 . Power dissipation and forward current are the values when the module temperature is set lower than the rating by using an adequate heat sink.
- ※ 2 . The maximum rating of reverse voltage is assumed to happen in short time by the initial connection error.
(Not dealing with the possibility of always-on reverse voltage.)
- ※ 3 . Operating temperature is the Case temperature T_c
(Refer to measuring point for case temperature in the next page.)
Refer "Derating curve" in the 3-4) for Operating temperature at operating current.
- ※ 4 . T_c=25°C or within derating curve temperature at operating current.

3-2) Electro-Optical Characteristics

(Measured at 400mA, T_j=90°C)

Product Code	Nominal CCT	CRI		Luminous Flux		Voltage		
		Ra Min.	Ra Typ	Min.	Typ.	Min.	Typ.	Max.
GC27	2700	90	93	310	340	8.0	8.7	9.6
GC30	3000	90	93	335	365			
GC40	4000	90	93	350	380			

Notes:

- ※ 5 . Measurement tolerance: Voltage ± 3 %, Luminous Flux ±7%, Ra ±2

3-3) Chromaticity Characteristics

Measured at 400mA, Tj=90°C

x,y tolerance : +/- 0.005

Bin	CIE X	CIE Y
27	0.459	0.414
	a	b
	0.00773	0.00401
	θ	
		57.3

Bin	CIE X	CIE Y
30	0.435	0.402
	a	b
	0.00835	0.00410
	θ	
		53.2

Bin	CIE X	CIE Y
35	0.407	0.392
	a	b
	0.00927	0.00414
	θ	
		54.0

Bin	CIE X	CIE Y
40	0.381	0.379
	a	b
	0.00939	0.00403
	θ	
		53.7

* Each color area stay within MacAdam 3-step ellipse from the chromaticity center.

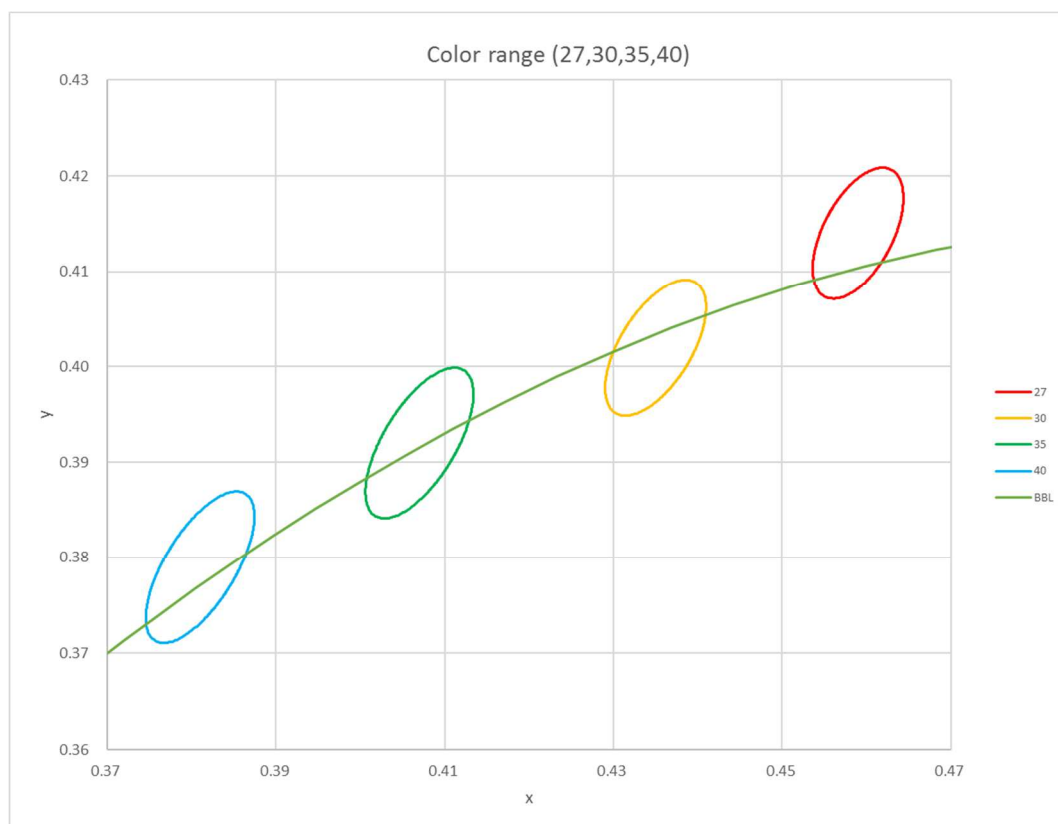

3-4) Derating Curve

To keep the LED in good reliability use, Case temperature (T_c) of COB must below the rating curve by attaching an adequate heat sink.

Please measure T_c in actual usage condition.

Below T_c derating curve is only applicable to right condition of installation written in precautions.

Especially heat sink surface must be flat on backside of COB and well thermally conducted.

If heatsink under T_c point of COB is not flat, please use the different point on COB with same distance from center of LES as T_c point.

Please ensure that T_c does not exceed derating curve even after installation and operation as final product.

(Measuring point for case temperature)

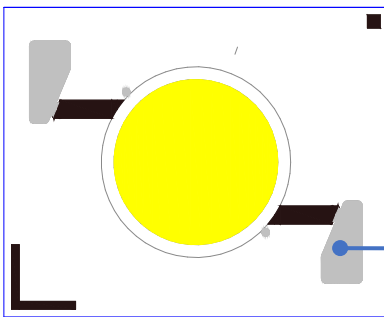

- COB mounting surface should be flat and plain.
- Substrate surface temperature should be uniform when measuring case temperature.

Thermal Resistance ($^{\circ}C/W$)

6.4

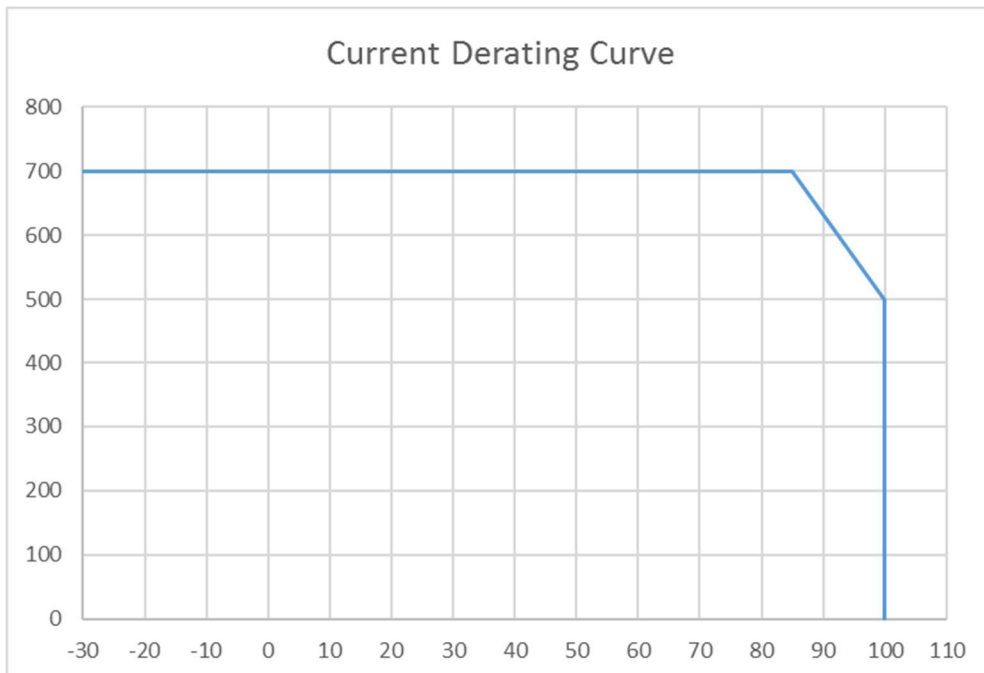

3-5) Characteristics Diagram (TYP.)

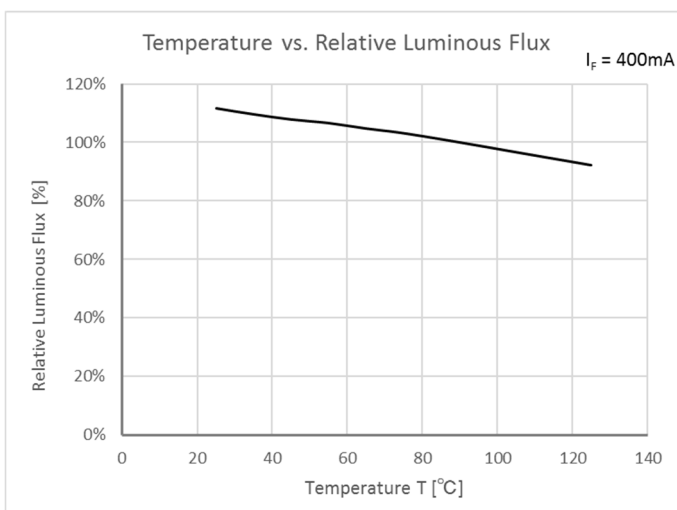
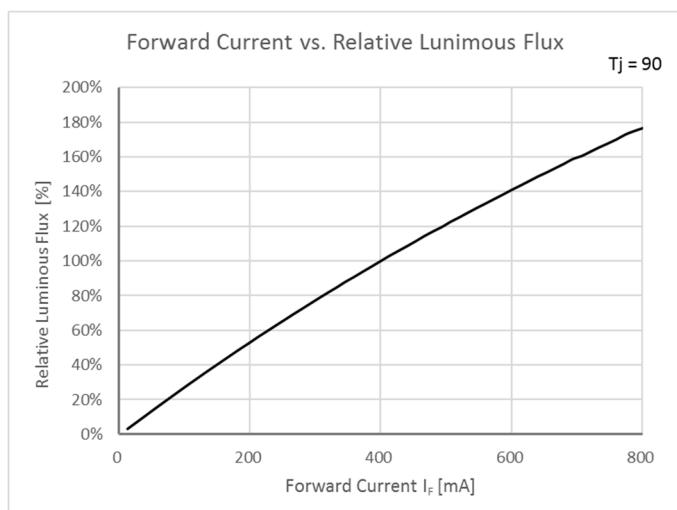
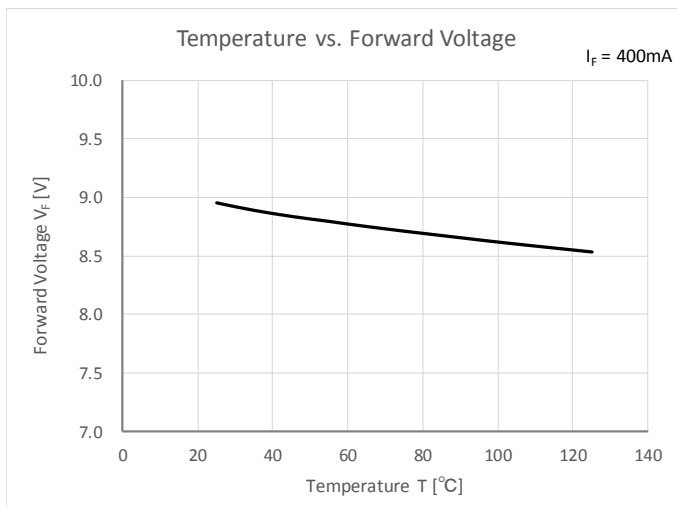
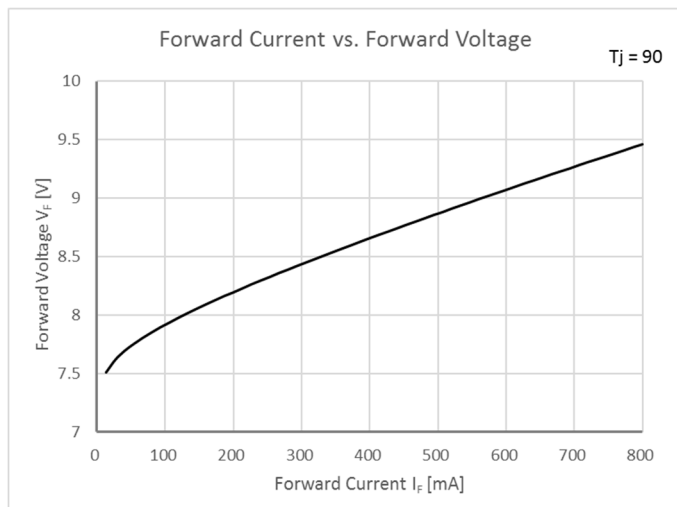

Notes:

- ※ 1. Temperature shown in above for Tc temperature at instantaneous operation, and Tj is equal to Tc for such operation. Please refer above chart as reference of temperature dependency of LED characteristics.
- ※ 2. Characteristics data shown here are for reference purpose only. (Not guaranteed data)

3-6) Spectrum and Color (Reference)

Spectrum data for 3000K G type (CRI > 90) and for M type (CRI > 80)

(Measured at 400mA, Tj=90°C)

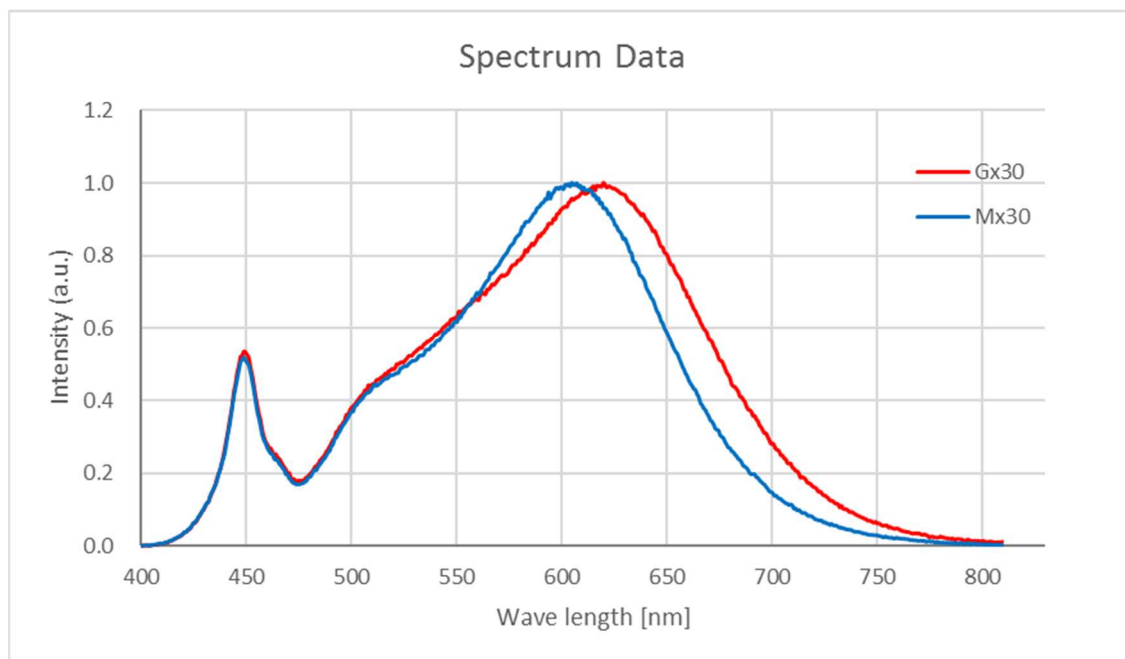

Color Index 3000K G type (CRI > 90)

CRI	R1	R2	R3	R4	R5	R6	R7	R8	R9	R10	R11	R12	R13	R14	R15
93	93	96	97	94	93	95	93	83	60	90	94	83	94	98	89
CQS	Q1	Q2	Q3	Q4	Q5	Q5	Q7	Q8	Q9	Q10	Q11	Q12	Q13	Q14	Q15
93	89	94	94	95	99	94	93	93	94	91	89	96	91	95	91

Color Index 3000K M type (CRI > 80)

CRI	R1	R2	R3	R4	R5	R6	R7	R8	R9	R10	R11	R12	R13	R14	R15
84	82	91	97	83	82	89	84	61	10	80	83	75	84	99	74
CQS	Q1	Q2	Q3	Q4	Q5	Q5	Q7	Q8	Q9	Q10	Q11	Q12	Q13	Q14	Q15
85	73	85	88	92	97	89	86	86	89	84	83	95	82	86	80

3-7) Radiation Beam Angle (Reference)

FWHM (full width at half maximum) : 120 degree

4. Reliability

The reliability of products shall be satisfied with items listed below.

NO	Test Item	Condition	Samples n	Defective C
1	Temperature Cycle	-40°C~100°C / Dwell time 30min / 300 Cycles	8	0
2	High Temperature / Humidity Life	85°C/85%RH / 1000 H / @IF=400mA	8	0
3	Low Temperature Storage	-40°C / 1000 H	8	0
4	High Temperature Storage	100°C / 1000 H	8	0
5	High Temperature Life	Tc 85°C / 1000 H / @IF=400mA	8	0

Failure Criteria

(Measured at 400mA, Tj=90°C)

	Item	Symbol	Criteria
1	Forward Voltage	V_F	$V_F > \text{Initial value} \times 1.1$
2	Luminous Flux	Φ	$\Phi < \text{Initial value} \times 0.8$
3	CIE-x / CIE-y	$\Delta x, \Delta y$	$\Delta x, \Delta y < 0.02$

5. Packing and Labels

Packaging

- One tray composed of 80 pieces
 - 5 trays (400 pieces) and one upper lid-tray in one moisture-proof bag
 - 2 bags (800 pieces) in one carton
 - Dimensions of outer carton : 235 × 220 × 90 mm (Reference value)
- (Note 1) There are cases of one carton composed of one tray. (80 pieces~)
- (Note 2) State of packing is subject to change.

< Outer carton >
400 pieces × 2 bags = 800 pieces

< One bag >
80 pieces × 5 trays = 400 pieces

< One Tray >
10 x 8 = 80 pieces

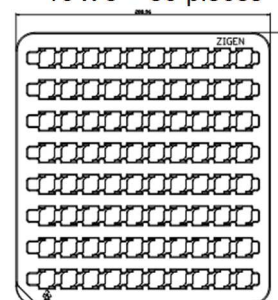
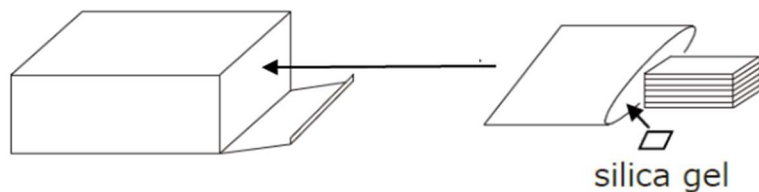

Labels

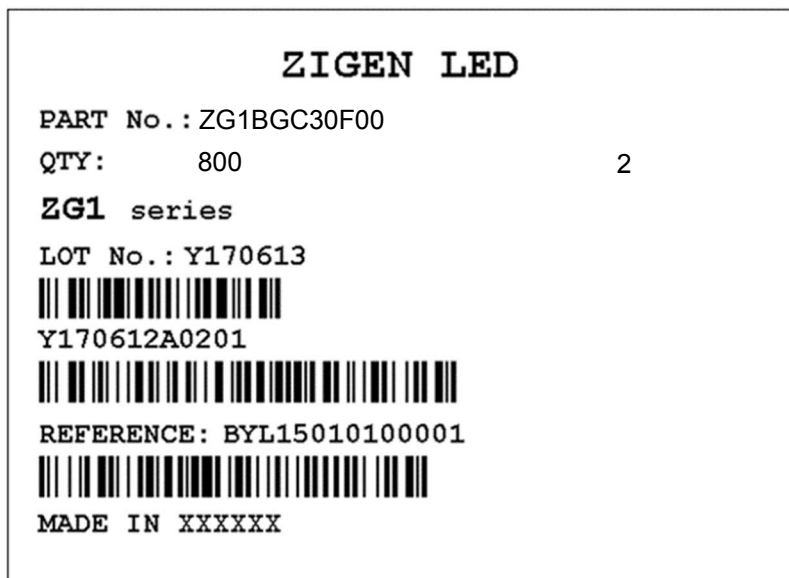

Indication printed on product

Model No. and control No. are indicated on substrate surface.

Control No.

Indicated as follows ;

1 G C 30 2
 ① ② ③ ④ ⑤
7 C 10
 ⑥ ⑦ ⑧

① 1 : Product generation

② M / G : CRI

③ C : Chip layout

④ 30 : Color

⑤ 2 : Rank

⑥ 7 : Year

⑦ C : Month

⑧ 10 : Date

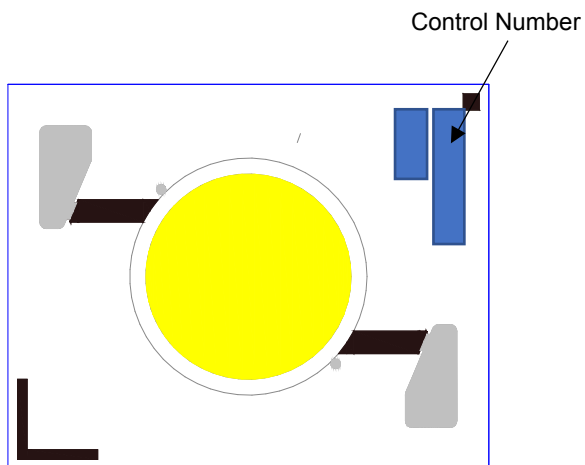

6. Precautions

1. Storage conditions

- Before the package is opened: The LEDs should be stored at 30°C or less and 50%RH or less after being delivered and the storage life limit is 6 months. If the LEDs are stored for 6 months or more, they should be stored in a sealed container with a nitrogen atmosphere and moisture absorbent material.
- After opening the package: The LED should be stored under 30°C or less and 30%RH or less. The LED should be used within 7days after opening the package. If unused LEDs remain, it should be stored in moisture proof packages with absorbent.
- Please avoid exposing air with corrosive gas.

2. Handling of COB

- Do not put mechanical stress on the LED.
- Never touch the optical surface with finger or sharp object. The LED surface could be soiled or damaged, which could affect the optical performance of the LED.
- Please keep handling the LEDs with appropriate ESD grounding, especially in low-humidity work environment.
- It is recommended to handle the LED with powder-less latex gloves.
- Do not touch the resin with tweezers to avoid scratching or other damage.
- Please use IPA when cleaning COB

3. Assembly conditions

- Please use appropriate heatsink and thermal conductor (heat conductive glue/adhesive/sheet etc) for mounting COB to control Tc temperature.
- Please do not use convex or rough surface or not clean heatsink.
- Please make sure COB will not detach from heatsink through life of finish product.
- When using holder please avoid to use harmful outgas (Cl, Br etc) contain material (Br contain PBT etc) and make sure it's reliability is enough in temperature and light from COB.
- Please make sure thermal conductor on back side of LED will not reduce performance through life of finish product.
- Please avoid keep convex stress during and after installation, which may cause crack in long use.
- Please do not touch or hold by resin area and handle by ceramic substrate part only.

4. Connecting method

- Connection by solder wire with 380 degree tip-temperature tool under 5seconds is recommended.
- Please solder whole solder pad area.
- Please avoid to touch resin part by soldering tool.
- This product is not designed for reflow and flow soldering.
- Please prevent to pull lead connected to solder pad and pulling stress after installation.

- Please prevent to use flux.
- Please verify solder wire contented flux is no more activated after soldering.
- In case using holder connector, please verify electric connectivity for long use.

5. Usage conditions

- Please check reliability well enough under finish product condition before using for mass production.
- Please avoid use or verify reliability in a place with high moisture and corrosive gas (halogen, H₂S, NH₃, SO₂, NO_x etc)
- Please avoid use or verify reliability under direct sun right condition, exposure in outdoor and dusty place.
- Please avoid use or verify reliability to use in liquid like water, oil and solvent.
- Please avoid use under strong acidic or alkali atmosphere condition.

6. Operation

- Any reverse voltage cannot be applied after installation.
- Please use appropriate protective device to avoid surge or high voltage.

7. Safety

- Please be care to LED light from injuring eyes.
- Please avoid flammable goods from strong light intensity area.
- Please follow appropriate regulations and lows for usage as lighting product.

8. Others

- Any uncertain or necessity of suggestion in usage, please consult with sales representative.
- Please follow the latest assemble guide, available in the website of ZIGEN.
- All information in this document is subject to be updated without prior notice.
- Please confirm the latest datasheet with sales representative and exchange formal specification before starting purchase for mass production