

ZIGEN LED DATASHEET

Series Part Number

ZG6CGD_{xx}Z0T

TRIPLE COLOR SWITCH COB LED

| Contents | Page |
|---|-------|
| 1 Product Description & Features | 2 |
| 2 External Dimension & Circuit diagrams | 3 |
| 3 Ratings and Characteristics | 4-8 |
| 1) Absolute Maximum Ratings | |
| 2) Electro-Optical Characteristics | |
| 3) Chromaticity Characteristics | |
| 4) Derating Curve | |
| 5) Characteristics Diagram (TYP.) | |
| 6) Spectrum and Color (Reference) | |
| 4 Reliability | 9 |
| 5 Packing and Labels | 10 |
| 6 Precautions | 11~12 |

- Contents in this document is subject to change without prior notice.

1. Product Description

ZIGEN is targeting to professional lighting market from innovative concepts and quality driven development.

ZG6CGxxxZ0T is under ZIGEN VI series (ZG6) with features below

- Mechanical Dimensions : 19.0 x 19.0 x 1.5 (mm)
- High Efficiency Color Switch COB in good color control
- ▲ connection : low CCT
- All connection : middle CCT
- ▼ connection : high CCT
- No disconnection for color switch, avoiding hot plug
- Substrate : Aluminum

ZG6 C G x xx Z 0 T
 [1] [2] [3] [4] [5] [6] [7] [8]

| | | |
|-----|----------------|--|
| [1] | Series code | ZG6 |
| [2] | Substrate size | C (19x19mm) |
| [3] | CRI | G (>90) |
| [4] | Chip Layout | D (12s9p) |
| [5] | Color code | WM (2700K-3000K-3500K) |
| [6] | Substrate type | Z (LES 15.0mm, 4-pad) |
| [7] | Test Condition | 0 (cold) |
| [8] | Custom code | T (tripe color switch by connection channel) |

2. External Dimension & Circuit Diagram

- External Dimension

Unit : mm

Tolerances unless specified : +/-0.1

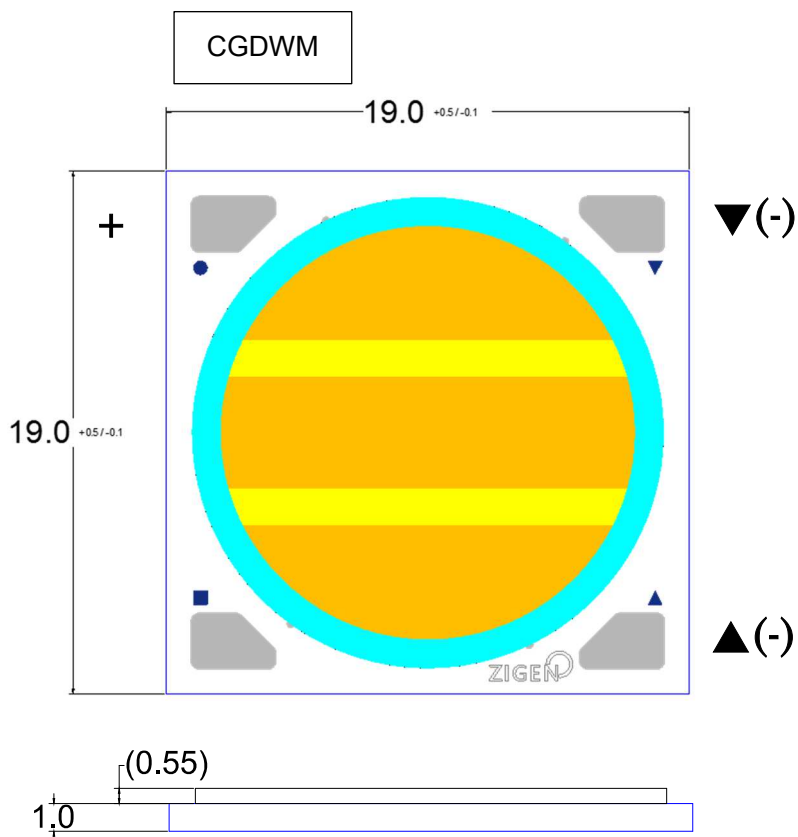

Notes: Values inside parentheses are reference values.
 External sizes of are determined by maximum dimensions,
 that include salient areas on the edges of respective sides.

3. Ratings and Characteristics

3-1) Absolute maximum ratings

| Parameter | Symbol | Ratings | Unit |
|-----------------------------------|------------------|------------|------|
| Max. DC Forward Current (mA) ※1,4 | I _F | 1000 | mA |
| Power Dissipation ※1,4 | P _d | 37 | W |
| Reverse Voltage ※2,4 | V _R | -5 | V |
| Max. Junction Temperature | T _j | 145 | °C |
| Operating Temperature ※3 | T _{Opr} | -30 ~ +100 | °C |
| Storage Temperature | T _{Stg} | -40 ~ +100 | °C |

Notes:

- ※ 1. Power dissipation and forward current are the values when the module temperature is set lower than the rating by using an adequate heat sink.
- ※ 2. The maximum rating of reverse voltage is assumed to happen in short time by the initial connection error.
(Not dealing with the possibility of always-on reverse voltage.)
- ※ 3. Operating temperature is the Case temperature T_c
(Refer to measuring point for case temperature in the next page.)
Refer "Derating curve" in the 3-4) for Operating temperature at operating current.
- ※ 4. T_c=25°C or within derating curve temperature at operating current.

3-2) Electro-Optical Characteristics

(Measured at 700mA, T_j=25°C)

| Product Code | Wire Connection | Nomical CCT | CRI (Ra) | | Luminous Flux | | Voltage | | |
|--------------|-----------------|-------------|----------|-----|---------------|------|---------|------|------|
| | | | Min. | Typ | Min. | Typ. | Min. | Typ. | Max. |
| ZG6CGD | ▲ | 2700 | 90 | 92 | 2700 | 3000 | 31.2 | 34.6 | 38.0 |
| WMZ0T | ▲+▼ | 3000 | 90 | 92 | 2850 | 3150 | 30.6 | 33.9 | 37.2 |
| | ▼ | 3500 | 90 | 92 | 2850 | 3150 | 31.8 | 35.2 | 38.7 |
| ZG6CGD | ▲ | 2700 | 90 | 92 | 2480 | 2750 | 31.1 | 34.5 | 37.9 |
| W4Z0T | ▲+▼ | 3000 | 90 | 92 | 2580 | 2850 | 30.6 | 33.9 | 37.2 |
| | ▼ | 4000 | 90 | 92 | 2620 | 2900 | 32.7 | 36.1 | 39.6 |

Notes:

- ※ 5. Measurement tolerance: Voltage ± 3 %, Luminous Flux ±7%, Ra ±2

3-3) Chromaticity Characteristics

(Measured at typical current)

x,y tolerance : +/- 0.005

Tj=25 degree

| | | | | | |
|---------------------------|---|--------|--------|--------|--------|
| 2700K | x | 0.4517 | 0.4634 | 0.4684 | 0.4564 |
| (Color Code = Wx) | y | 0.4125 | 0.4125 | 0.4225 | 0.4225 |

| | | | | | |
|---------------------------|---|--------|--------|--------|--------|
| 3000K | x | 0.4287 | 0.4404 | 0.4454 | 0.4334 |
| (Color Code = 3x) | y | 0.4025 | 0.4025 | 0.4125 | 0.4125 |

| | | | | | |
|---------------------------|---|--------|--------|--------|--------|
| 3500K | x | 0.4017 | 0.4134 | 0.4184 | 0.4064 |
| (Color Code = xM) | y | 0.3900 | 0.3900 | 0.4000 | 0.4000 |

| | | | | | |
|---------------------------|---|--------|--------|--------|--------|
| 4000K | x | 0.3742 | 0.3859 | 0.3909 | 0.3789 |
| (Color Code = x4) | y | 0.3805 | 0.3805 | 0.3905 | 0.3905 |

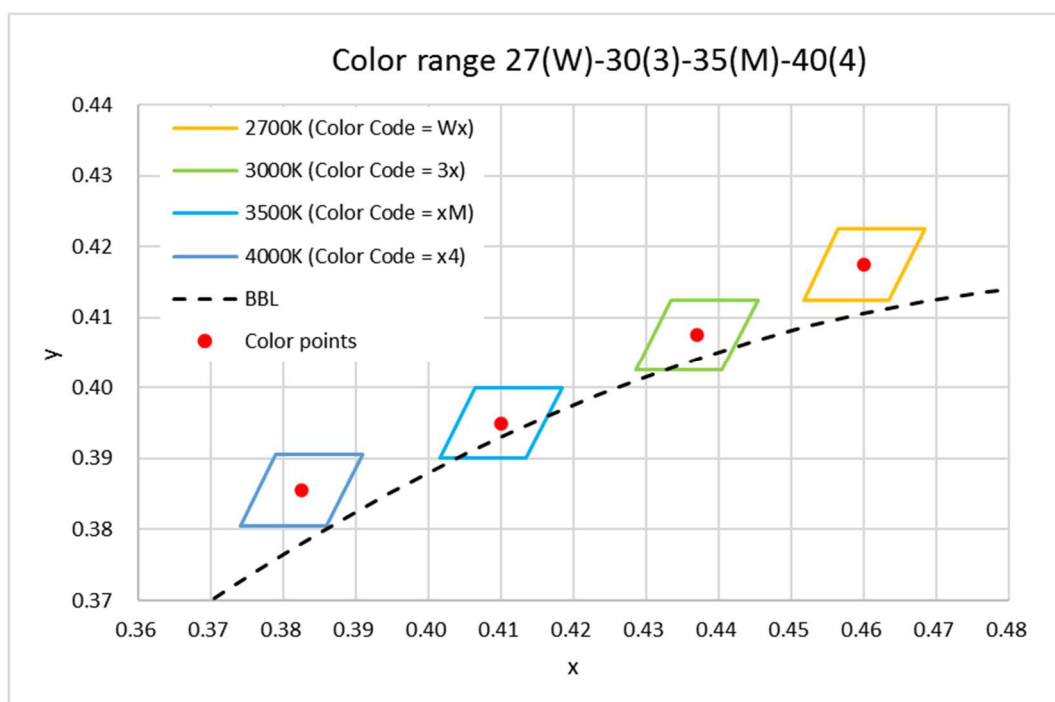

3-4) Derating Curve

To keep the LED in good reliability use, Case temperature (T_c) of COB must below the rating curve by attaching an adequate heat sink.

Please measure T_c in actual usage condition.

Below T_c derating curve is only applicable to right condition of installation written in precautions.

Especially heat sink surface must be flat on backside of COB and well thermally conducted.

If heatsink under T_c point of COB is not flat, please use the different point on COB with same distance from center of LES as T_c point.

Please ensure that T_c does not exceed derating curve even after installation and operation as final product.

(Measuring point for case temperature)

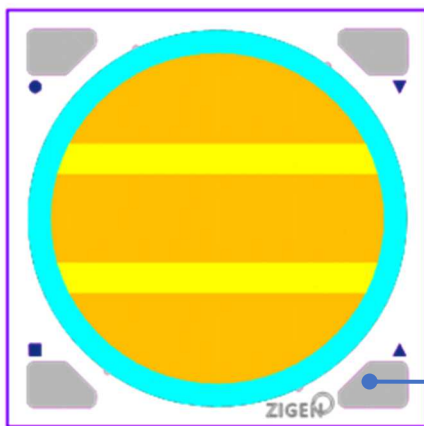

- COB mounting surface must be flat and plain.
- Substrate surface temperature must be uniform when measuring case temperature.

Measuring point

Thermal Resistance ($^{\circ}C/W$)

1.25 for CGDWM, 1.5 for CGDW4

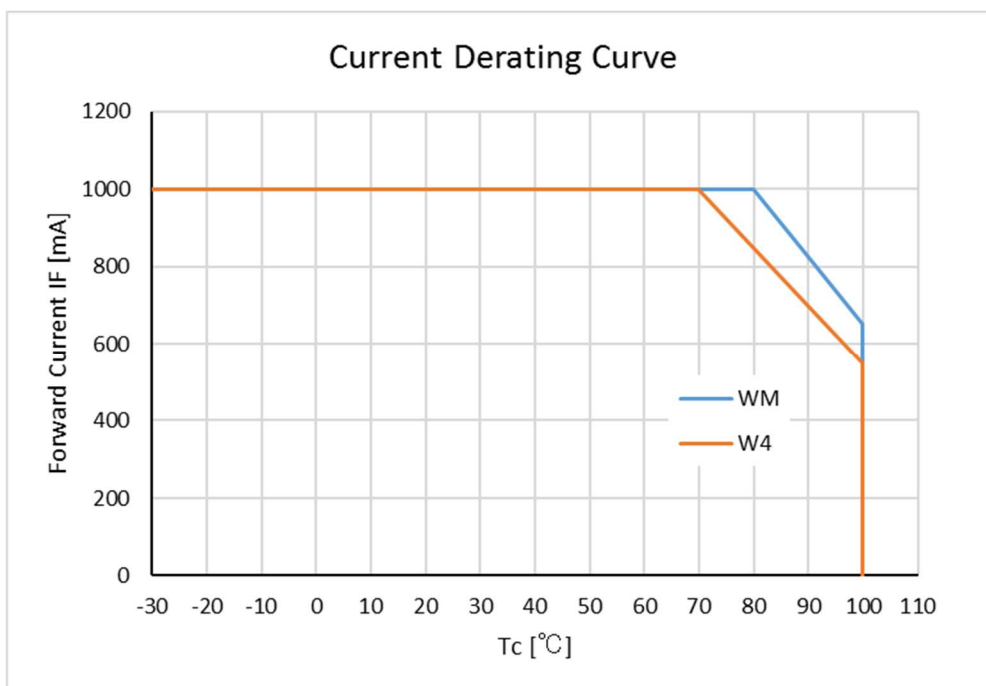

3-5) Characteristics Diagram (TYP.) <ZG6CGDWMZ0T characteristics>

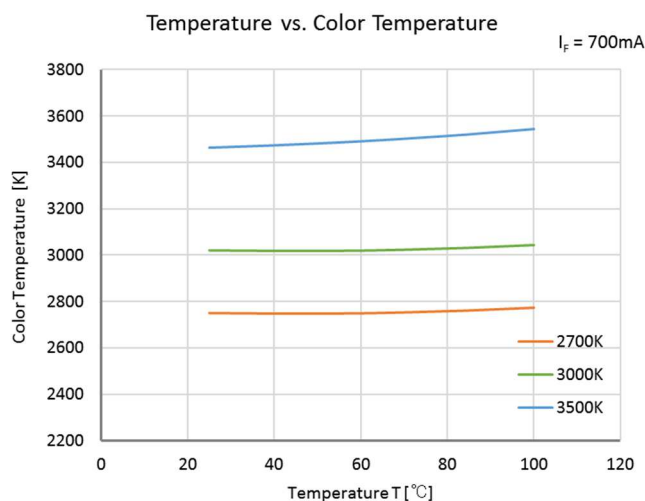
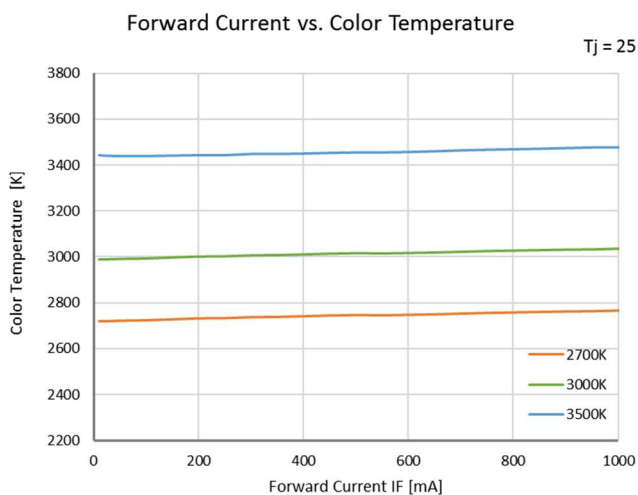
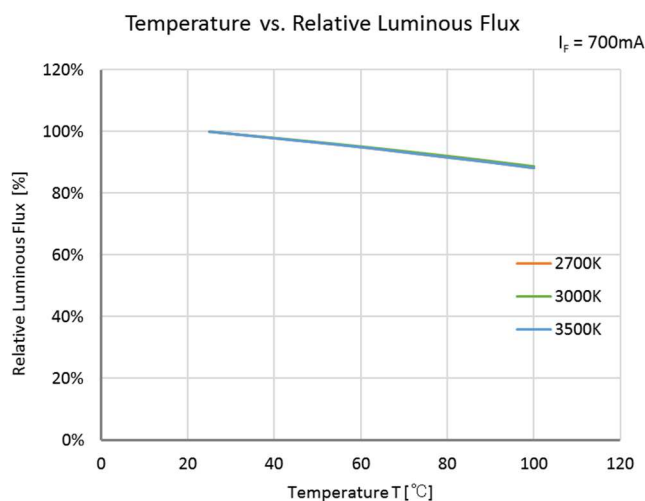
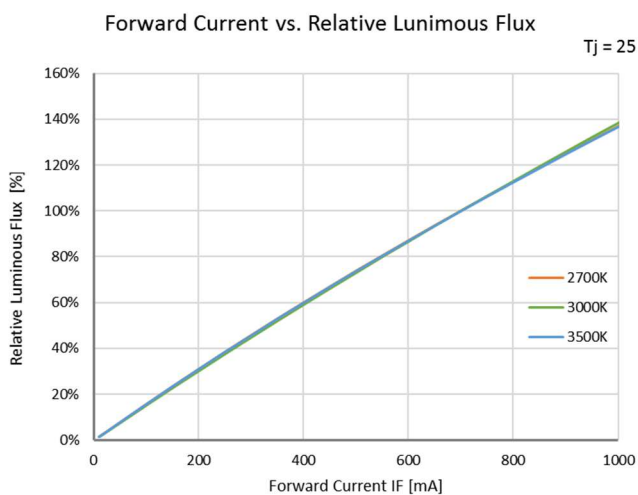
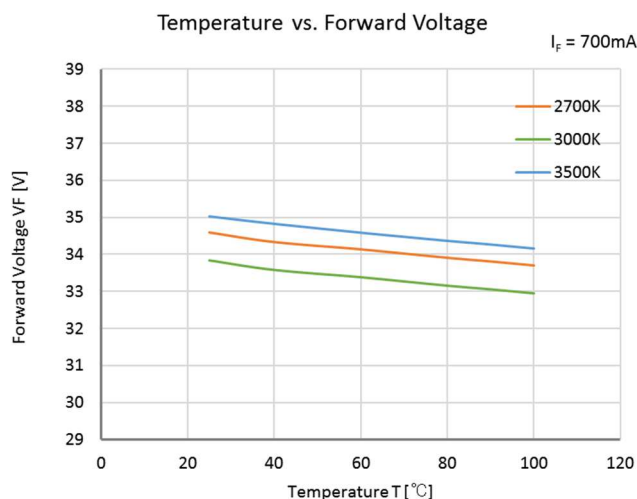
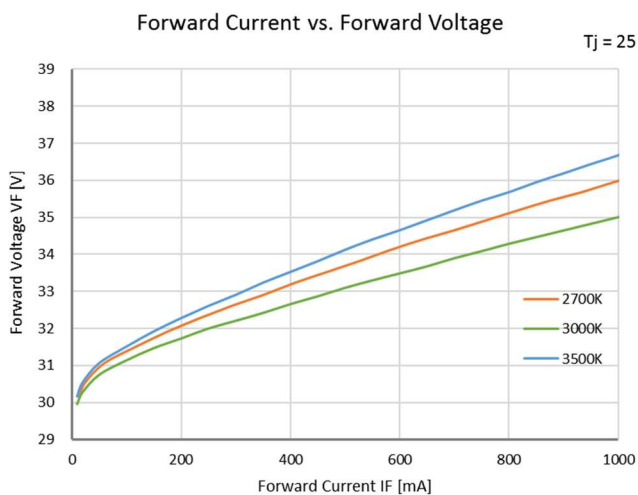

Notes:

- ※ 1. Temperature shown in above for T_c temperature at instantaneous operation, and T_j is equal to T_c for such operation. Please refer above chart as reference of temperature dependency of LED characteristics.
- ※ 2. Characteristics data shown here are for reference purpose only. (Not guaranteed data)

3-6) Spectrum and Color (Reference)

Spectrum data for 2700K, 3000K, 3500K, 4000K (Ra>90)

(Measured at typical current, Tj=25°C)

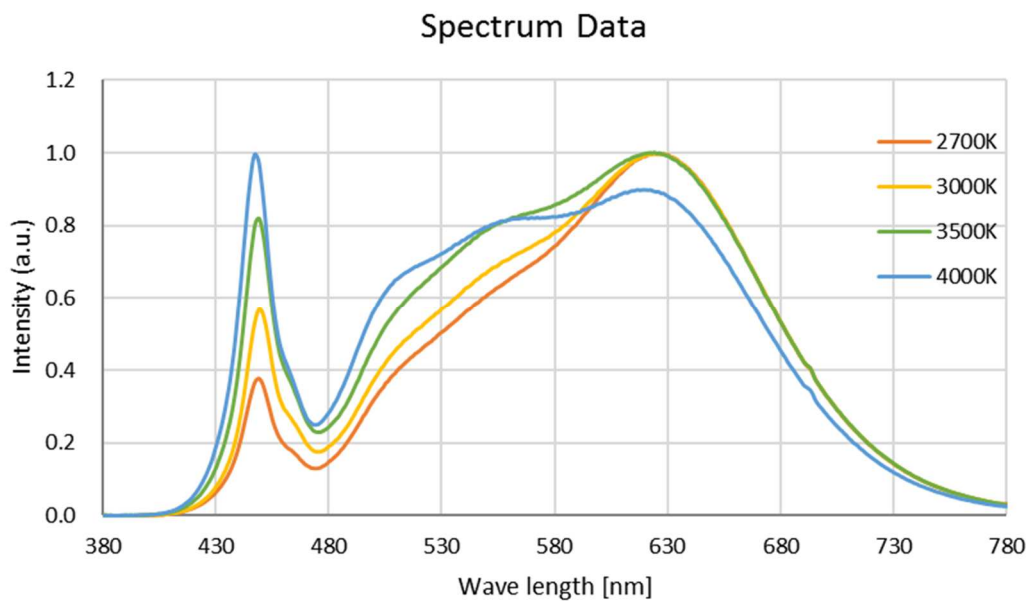

※ Spectrum data shown here are for reference purpose only. (Not guaranteed data)

4. Reliability

The reliability of products shall be satisfied with items listed below.

| NO | Test Item | Condition | Samples n | Defective C |
|----|-------------------------------------|---|--------------|----------------|
| 1 | Temperature Cycle | -40°C~100°C / Dwell time 30min / 300 Cycles | 4 | 0 |
| 2 | High Temperature / Humidity Storage | 85°C/85%RH / 1000 H | 4 | 0 |
| 3 | Low Temperature Storage | -40°C / 1000 H | 4 | 0 |
| 4 | High Temperature Storage | 100°C / 1000 H | 4 | 0 |
| 5 | High Temperature Life | Tc 85°C / 1000 H / @IF=700mA (CGD) | 4 | 0 |

Failure Criteria

(Measured at typical current, Tj=25°C)

| | Item | Symbol | Criteria |
|---|-----------------|----------------|--------------------------------------|
| 1 | Forward Voltage | V _F | V _F > Initial value x 1.1 |
| 2 | Luminous Flux | Φ | Φ < Initial value x 0.8 |
| 3 | CIE-x / CIE-y | Δx, Δy | Δx, Δy < 0.02 |

5. Packing and Labels

Packaging

- One tray composed of 24 pieces
 - 15 trays (360 pieces) and one upper lid-tray in one moisture-proof bag
 - 1 bags (360 pieces) in one carton
 - Dimensions of outer carton : 235 × 220 × 90 mm (Reference value)
- (Note 1) There are cases of one carton composed of one bag. (30 pieces~)
- (Note 2) State of packing is subject to change.

< Outer carton > 360 pieces × 1 bags = 360 pieces < One bag > 24 pieces × 15 trays = 360 pieces < One Tray > 4 x 6 = 24 pieces

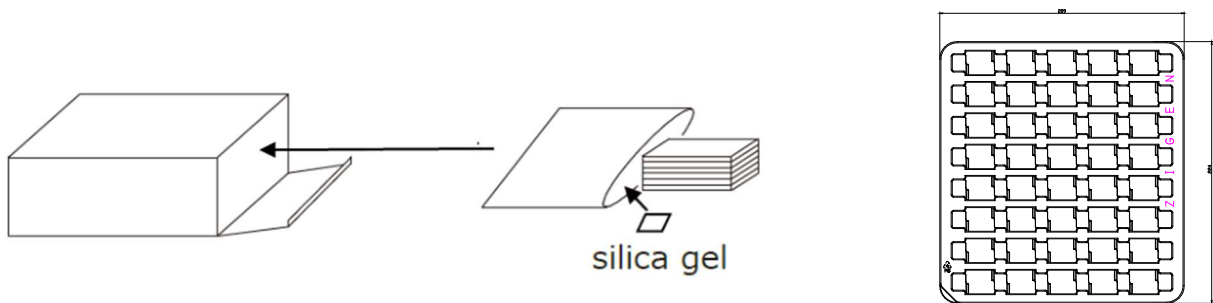

Indication printed on product

Model No. and control No. are indicated on substrate surface.

Control No.

Indicated as follows ;

I M 0 C 2
 ① ② ③ ④ ⑤

- ① T : Chip layout
(T: 35W TRI COLOR)
- ② M : Ra/Color code / rank
(M: 2700-3000-3500K Ra90,
U: 2700-3000-4000K Ra90)
- ③ 0 : Year
- ④ C : Month
- ⑤ 2 : Date (1~9,A~V)

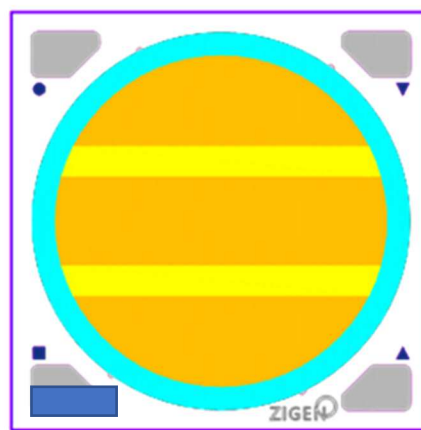

Control Number

6. Precautions

1. Storage conditions

- Before the package is opened: The LEDs should be stored at 30°C or less and 50%RH or less after being delivered and the storage life limit is 6 months. If the LEDs are stored for 6 months or more, they should be stored in a sealed container with a nitrogen atmosphere and moisture absorbent material.
- After opening the package: The LED should be stored under 30°C or less and 30%RH or less. The LED should be used within 7days after opening the package. If unused LEDs remain, it should be stored in moisture proof packages with absorbent.
- Please avoid exposing air with corrosive gas.

2. Handling of COB

- Do not put mechanical stress on the LED, and Do not bend substrate.
- Never touch the optical surface with finger or sharp object. The LED surface could be soiled or damaged, which could affect the optical performance of the LED.
- Please keep handling the LEDs with appropriate ESD grounding, especially in low-humidity work environment.
- It is recommended to handle the LED with powder-less latex gloves.
- Do not touch the resin with tweezers to avoid scratching or other damage.
- Please use IPA when cleaning COB

3. Assembly conditions

- Please use appropriate heatsink to control Tc temperature
- Thermal conductor (heat conductive glue/adhesive/sheet etc) must be used for mounting COB to heat sink
- Please do not use convex or rough surface or not clean heatsink.
- Please make sure COB will not detach from heatsink through life of finish product.
- When using holder please avoid to use harmful outgas (Cl, Br etc) contain material (Br contain PBT etc) and make sure it's reliability is enough in temperature and light from COB.
- Please make sure thermal conductor on back side of LED will not reduce performance through life of finish product.
- Please avoid keep convex stress during and after installation, which may cause bending and affect thermal conductivity in long use.
- Please do not touch or hold by resin area and handle by Aluminum substrate part only.

4. Connecting method

- Connection by solder wire with 380 degree tip-temperature tool under 5seconds is recommended.
- Please solder whole solder pad area.
- Please avoid to touch resin part by soldering tool.

- This product is not designed for reflow and flow soldering.
- Please prevent to pull lead connected to solder pad and pulling stress after installation.
- Please prevent to use flux.
- Please verify solder wire contented flux is no more activated after soldering.
- In case using holder connector, please verify electric connectivity for long use.

5. Usage conditions

- Please check reliability well enough under finish product condition before using for mass production.
- Please avoid use or verify reliability in a place with high moisture and corrosive gas (halogen, H₂S, NH₃, SO₂, NO_X etc)
- Please avoid use or verify reliability under direct sun right condition, exposure in outdoor and dusty place.
- Please avoid use or verify reliability to use in liquid like water, oil and solvent.
- Please avoid use under strong acidic or alkali atmosphere condition.

6. Operation

- Any reverse voltage cannot be applied after installation.
- Please use appropriate protective device to avoid surge or high voltage.

7. Safety

- Please be care to LED light from injuring eyes.
- Please avoid flammable goods from strong light intensity area.
- Please follow appropriate regulations and lows for usage as lighting product.

8. Others

- Any uncertain or necessity of suggestion in usage, please consult with sales representative.
- Please follow the latest assemble guide, available in the website of ZIGEN.
- All information in this document is subject to be updated without prior notice.
- Please confirm the latest datasheet with sales representative and exchange formal specification before starting purchase for mass production

Revision History

Current version: **20060101**

Previous version: -

| Page | Subjects (major change in previous version) | Date of change |
|------|---|----------------|
| | | |
| | | |
| | | |
| | | |
| | | |